

Dahili Tipi Fiber Optik Terminasyon Kutusu

Genel Özellikler

- FTTH Sonlandırma Kutusu – 4 Port
- Sivaüstü F/O sonlandırma Kutusu - 4 Port
- Dahili tip Fiber optik terminasyon kutusu- 4 Port
- Fabrikalarda otomasyon sistemlerinde kullanılan fiberi sonlandırma için kullanılır. 4 port fiber kapasitesi ile endüstriyel cihazların ring yapısını destekler.
- Bina içinde patch panele gerek kalmadan fiber optik hattı sonlandırır
- Duvara monte edilebilir
- Box üzerinde 1 adet ek kaseti mevcuttur

Sonlandırma Kapasitesi

- SC simplex adaptör ile 4-fiber optik hat sonlandırma
- LC duplex adaptör ile 8-fiber optik hat sonlandırma

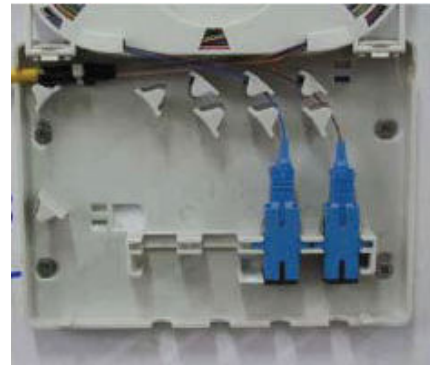
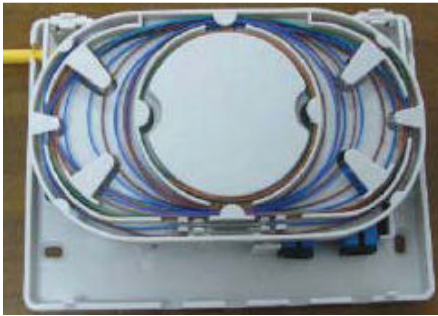

www.gym-tech.net

| Tel : +90 212 3204030
| Fax : +90212 3200255
| e-mail : info@telkolink.com
| Address : Perpa Ticaret Merkezi, A Blok No.516 Şişli/İstanbul

|Haberleşme & Telekom & Network Ürünleri



www.telkolink.com

FTB104B customer terminal box

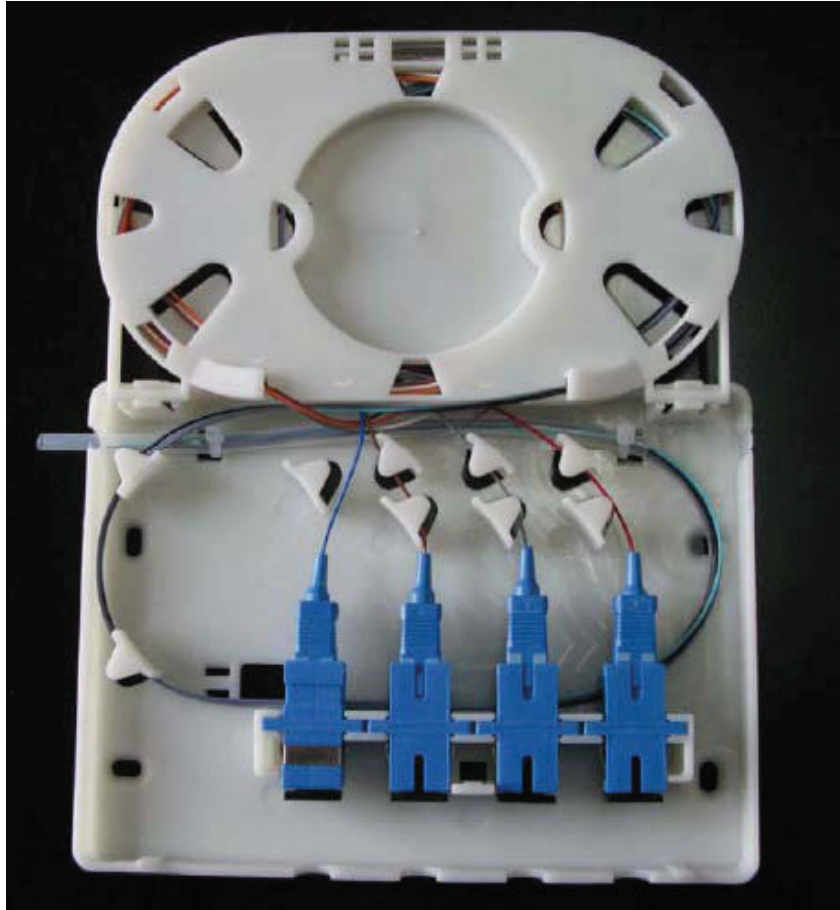

Introduction:

FTTH model of Fiber Optic Terminal Box is a newly developed by our company for application of FTTH. The box is light and compact, especially suitable for protective connection of fiber cables and pigtails in FTTH.

1. Features of the box

- 1.1 This box could be used for wall-mounted and rack-mounted applications;
- 1.2 The base and cover of the box adopts “self-clip” method, which is easy and convenient to open and close;
- 1.3 Could be used for adaptors such as SC,FC, etc;
- 1.4 The max capacity is 4 fibers;

2. The fiber route and main components of the box

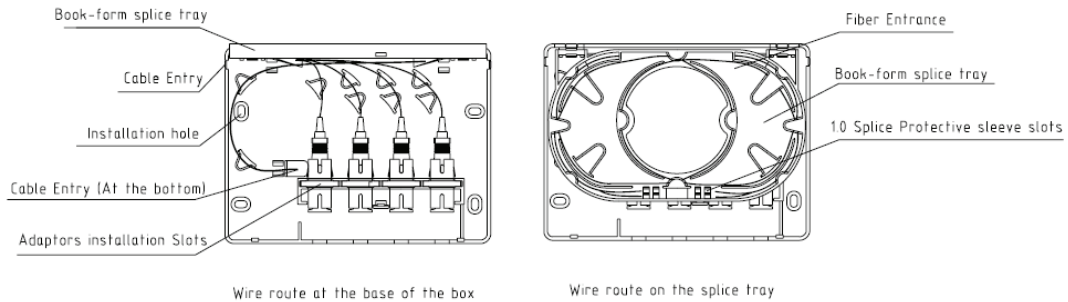

Pic1: The fiber route schematic diagram

3. Installation method

3.1 Open the package of the box to check all the components. See following Pic2 (the adapter is as optional component).



Pic2: components

3.2 Press the front side of the box, withdraw the cover and slide it backwards.

3.3 Indoor wiring fiber cable needed to lead in the location that fix the terminal box, the length of stripping is about 120cm from the end.



Pic 3: the length of stripped fiber cable



Pic4: fiber after stripping



Pic5: use EVA transparent tube to protect the stripped fiber

3.4 It is suitable for two routing methods: dark-routing and right-routing, see dark-routing leading in Pic6, see right-routing leading in Pic7/8.

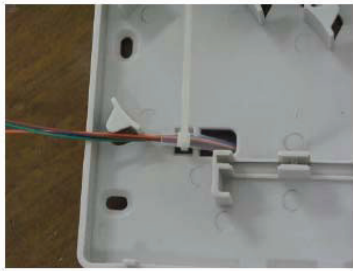

Pic6: dark-routing leads in box
fixes by nylon tie



Pic7: right-routing leads in box entrance

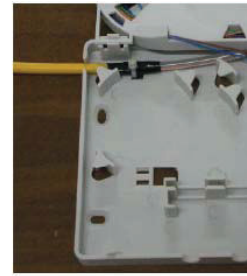

Pic8: right-routing leads in box and
and fixes by nylon tie

3.5 Outside fiber cable leads in fiber tray through cable outlet of tray as picture 9/10.

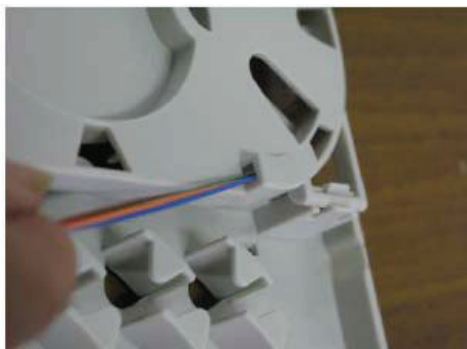

Pic9: thread the fiber to the cable inlet

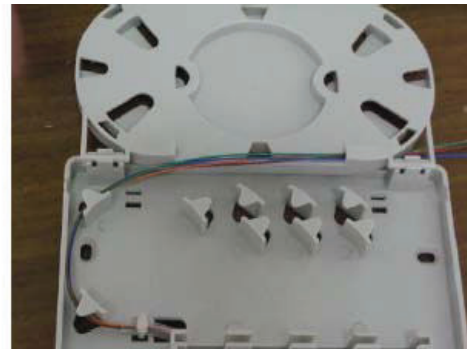

Pic10: the fiber leads in fiber tray

3.6 Installing the adaptor, inserting the pigtail plug, Taking the pigtail through into splice tray. Like Picture 11/12/13

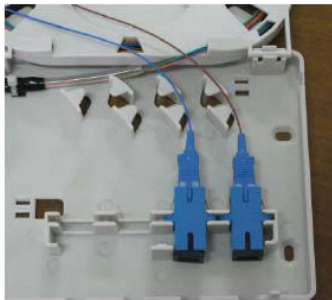

Pic11: install the adaptor and pigtail

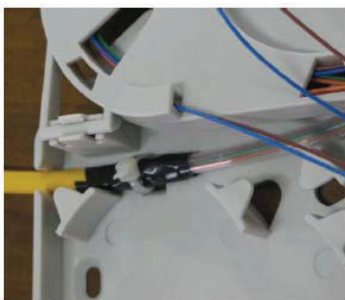

Pic12: put the pigtail through into the inlet port

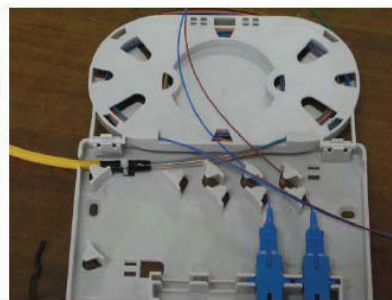

Pic13: pigtail inserted the
tray

3.7 Splice as per usual. Then put the splice protective tube into the slot of tray. Like picture 14/15/16



Pic14: after shrink, splice protective
tube put into the slot

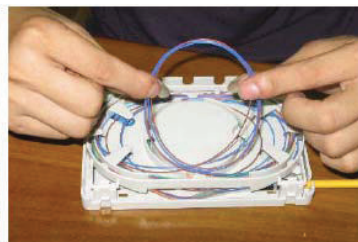

Pic15: splice



Pic16: panorama

4. The installation and application

4.1 According to the size of box size, drill the hole for M4 expand bolt as Pic17/18.

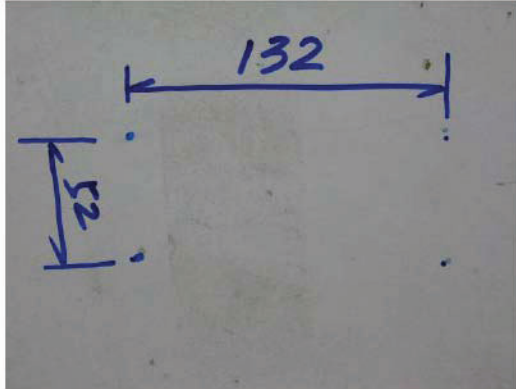

Pic17: the installation hole for the box wall-mount

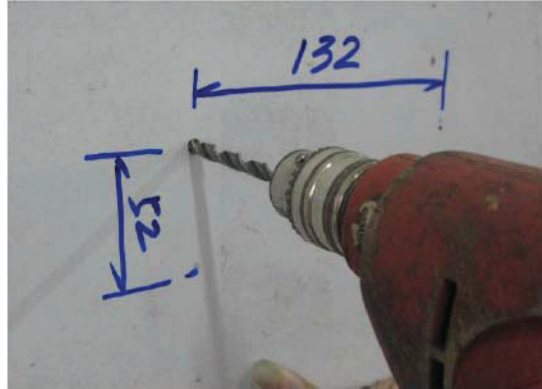

Pic18: drill the plastic expand hole

4.2 Knocking the plastic expand bolt into the hole.

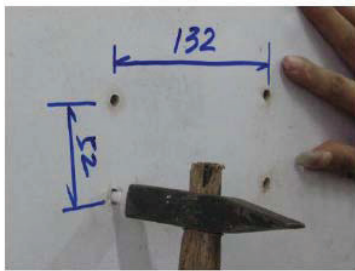

Pic19: knocking the plastic expand bolt



Pic20: fixing the box

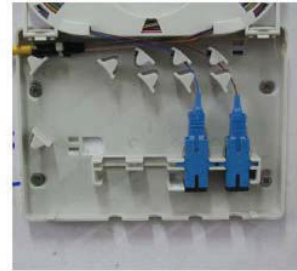

Pic21: the box after fixing

4.3 Fixing the box to wall with 4×25 screw thread bolt as Picture 20/21.

4.4 Cover the tray and terminal box



Pic22: cover the terminal box

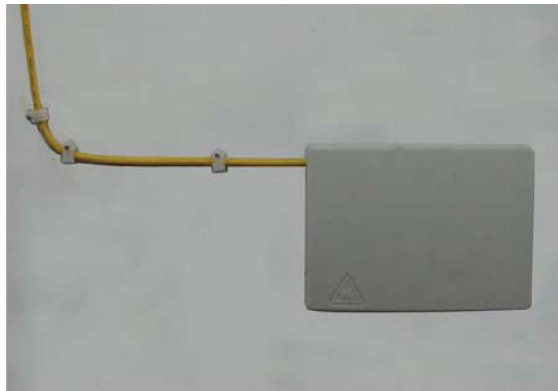

Pic23: after installation

5. Main Technical Indexes

5.1 Environmental Temperature: $-25^{\circ}\text{C} \sim 40^{\circ}\text{C}$;

5.2 Max capacity: 4 fibers;

5.3 Suitable types of fiber cables: 4 fibers indoor fiber cables;

www.telkolink.com

0 212 320 4030

yusuf@telkolink.com